

15 AIRBRIDGECARGO

Download our mob app

Download on the
App Store

GET IT ON
Google Play



We love
to make it happen.



You like reaching new heights.

AirBridgeCargo Airlines *at-a-glance*



AirBridgeCargo Airlines (ABC) was launched in 2004 as a division of Volga-Dnepr Group to perform international scheduled cargo services. Today, it is one of the leading international cargo airlines and a recognized leader in the Russian market. ABC transports its customers' freight all over the world, connecting shippers and consignees in Europe, North America, Asia and Russia.

Throughout its development, the airline has achieved strong growth, reporting a compound average tonnage increase of more than 15% in the last five years. ABC's remarkable performance is based on its focus and determination to build long-term relationships with customers around the world and deliver best-in-class service, both in the air and on the ground. The airline is committed to operating to the highest industry standards.

«It's so rewarding to be part of a team that not only values tried and true industry principles but combines them with innovative ideas. It's this mindset that allows us to keep growing and take our customers' businesses anywhere they want to be.

That's why we love our job.»



You like being globally connected.



#always
#worldwide



AirBridgeCargo Airlines *around the world*

AirBridgeCargo is one of the global air cargo carriers. Since the airline's initial Boeing 747 flight took off from Beijing to Luxembourg, ABC has achieved fifteen years of consecutive growth. Over the years, ABC has successfully expanded its network and cargo capacity, adding much needed support for customers in a challenging air cargo market. The carrier's success and growth are being spearheaded by the effective realization of its fleet expansion strategy, the development of solutions for special cargoes, the introduction of new destinations and the upgrading of existing ones as ABC continues to respond proactively to the capacity and service requirements of its customers worldwide.

Today, ABC is a sound name associated with quality and unparalleled service for various types of cargoes, including those requiring special handling&transportation conditions. The airline's fleet consists of 18 Boeing 747 freighters and is one of the youngest in the world. It is highly appreciated by the customers around the world as its operational capabilities are ideal for transportation of any type of cargo.

AirBridgeCargo Airlines is respected and well-known for its international expertise, highest quality and commitment to offering seamless, fast and safe transportation services.





You like business solutions that deliver.



We put our customers first in everything we do.

Understanding the needs of our clients is one of the major contributing factors in the company's development and meeting these needs is the goal of the more than 1,300 ABC employees worldwide. Our commitment to delivering the most effective air freight solutions is achieved by:

- Operating a modern all cargo fleet
- Presenting a greater choice of transportation opportunities by continually expanding ABC's global route network
- Creating confidence and trust in ABC's ability to consistently maintain the highest quality of service
- Investing in a professional, global team of experts based in every operating region
- Working with reliable and trust-worthy service providers
- Conducting two-way communication with our customers to guarantee proactive response to their needs

AirBridgeCargo has been recognized with a series of leading industry awards for the quality of its performance.

Awards



PLATINUM Air Carrier and Specialty Cargo Air Carrier
(up to 999,999 tonnes air carrier category)
Air Cargo Excellence Award 2019

Best Performing Newcomer Full-freighter Cargo Airline
BUD Annual Awards



Best All Cargo Airline – AFLAS 2016 | 2017 | 2018
Asia Cargo News (The Asian Freight, Logistic and Supply Chain Awards)

Payload Asia Awards 2016
'Media Award of the Year'



Anama Quality Awards 2016
Quality Overall Performance'

'Wings of Russia' Award 'Cargo Carrier of the Year'
for 4 consecutive years



Cargo Airline of the Year Awards, 2015
All-Cargo Airline of the Year'

Asian Freight and Supply Chain Awards, 2014
'Best All-Cargo Carrier'

«Exceeding expectations is one of our cardinal rules. We go above and beyond to make sure we meet the needs of our customers – their success is our success. That's why we love our job.»



You like efficiency at its best.

Loading dimensions of Boeing 747-8F

Maximum takeoff weight: 447,695 kg | 975,000 lb | Maximum landing weight: 329,761 kg | 761,000 lb

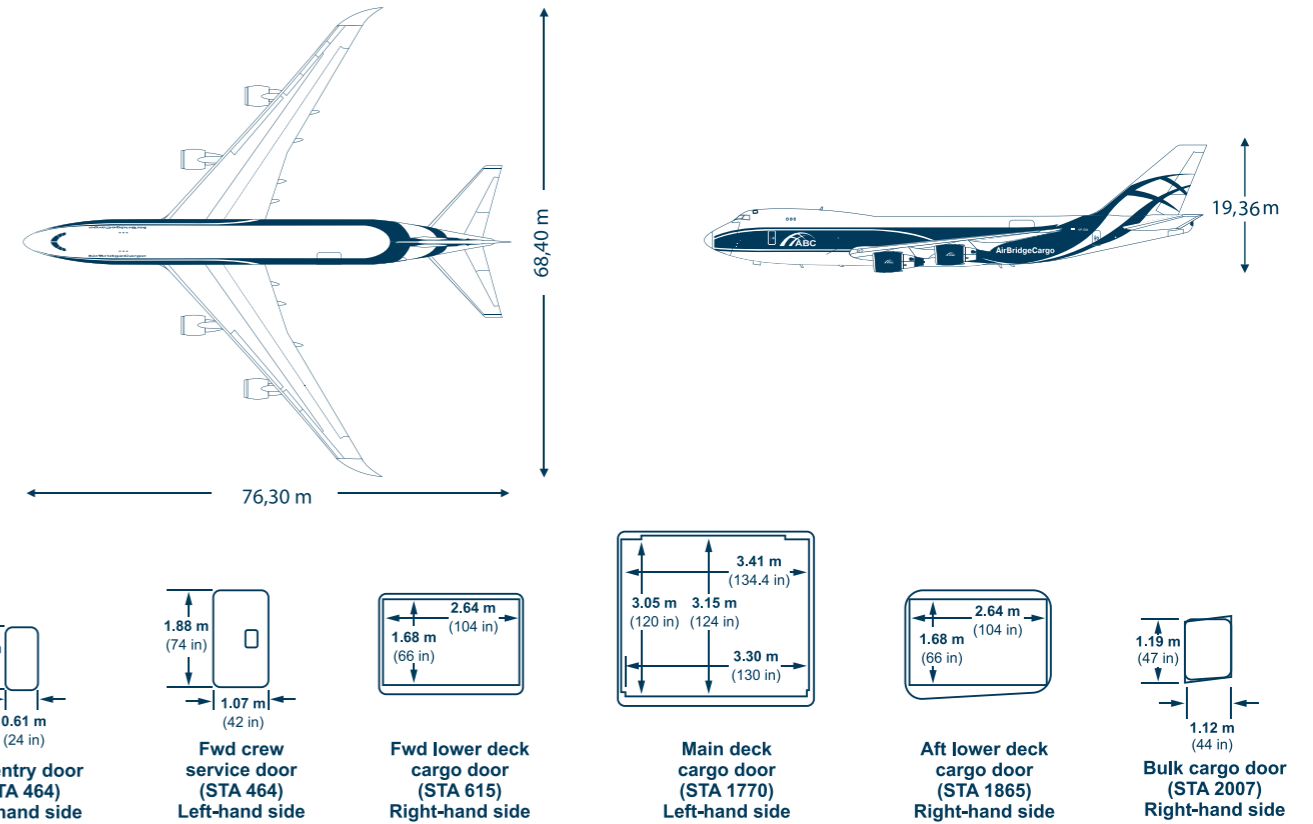

Delivered as promised. #always #worldwide

AirBridgeCargo operates a modern, efficient and capable fleet of Boeing 747 freighters.

ABC's all-Boeing fleet's capabilities offer a number of important benefits for the customers worldwide:

Currently, its fleet consists of 18 Boeing 747 freighters, comprising four Boeing 747-400ERFs, two B747-400Fs, and twelve of the latest generation Boeing 747-8Fs. The new generation 747-8 freighter offers an increased payload capacity of up to 139 tons on a single flight and can accommodate cargoes of up to 45 meters in length. AirBridgeCargo's services are also complemented by express and regional services, operated with five Boeing freighter aircraft type 737BCFs of Atran Airlines.

- Access to maindeck cargo capacity across AirBridgeCargo's entire global network
- 747: nose-door loading for oversized and priority shipments
- 747: separate cargo compartments with temperature settings of between 4°C to 29°C
- Lower CO₂ emissions

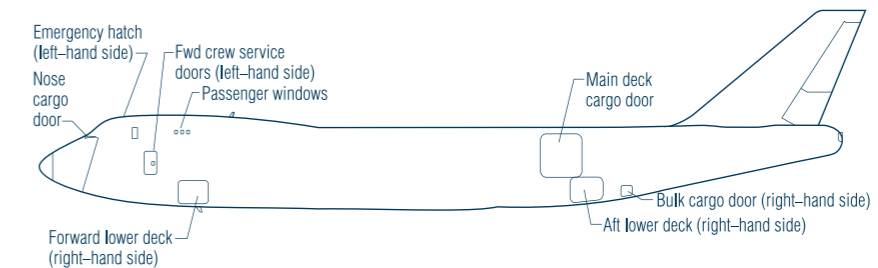
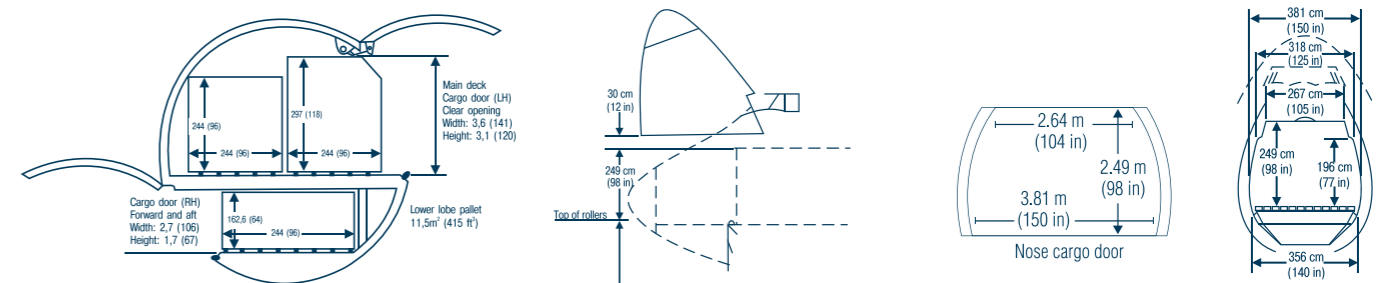

PYB

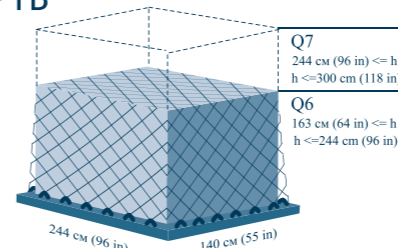

PGA/PGF

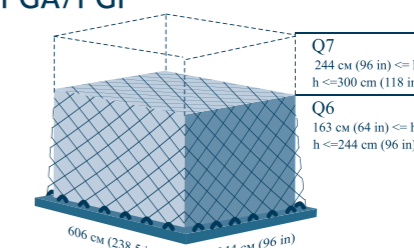

AKE

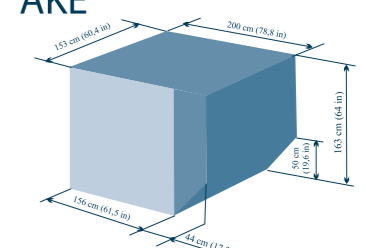

Loading dimensions of Boeing 747-400F (ERF)

Maximum takeoff weight: 412,769 kg | 910,000 lb | Maximum landing weight: 296,195 kg | 653,000 lb

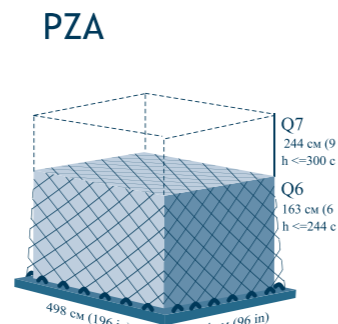
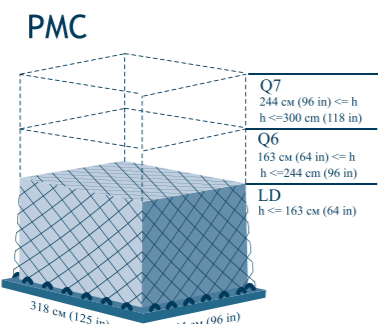
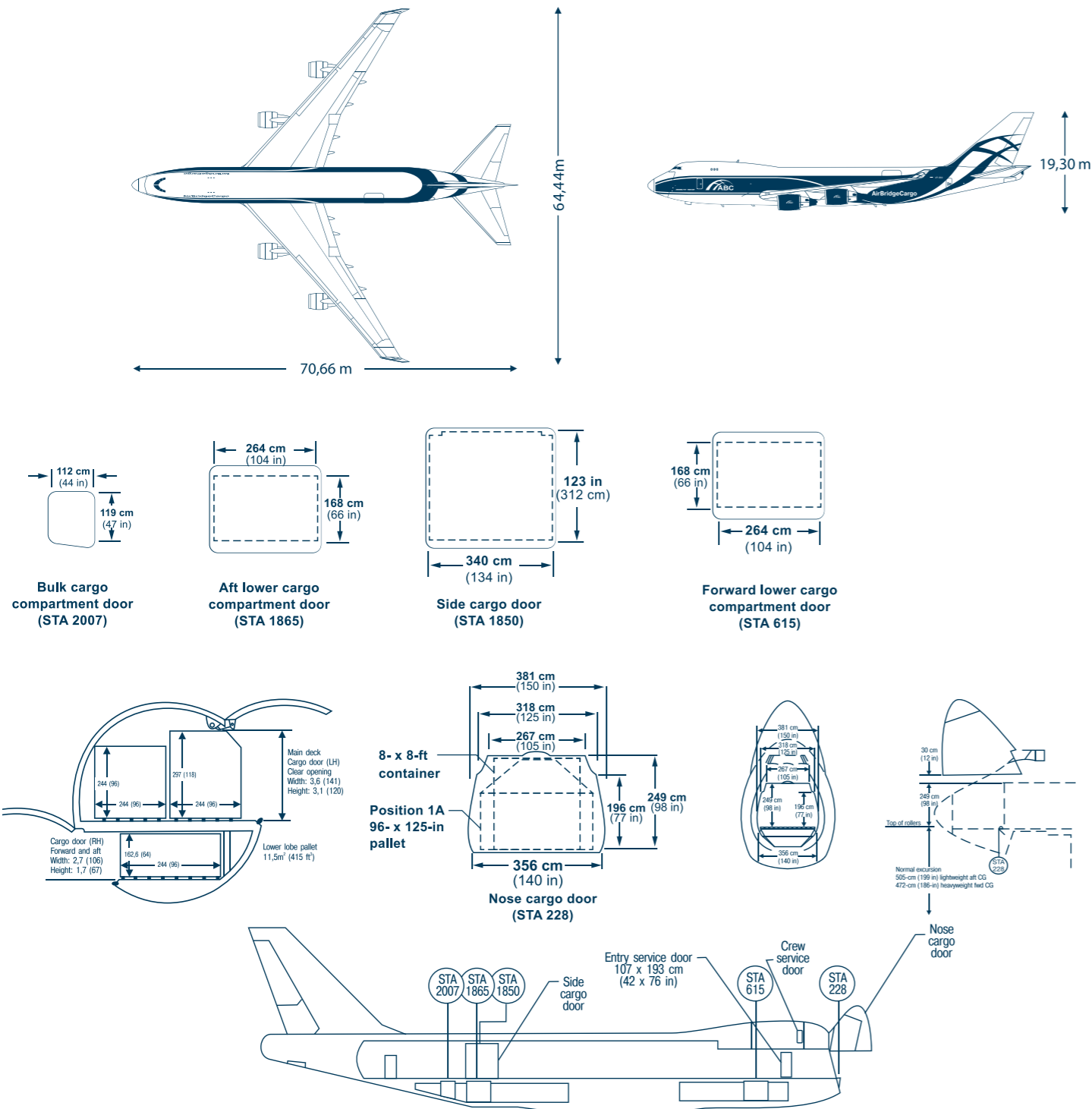

Loading dimensions of Boeing 737-800BCF | Boeing 737-400SF

Maximum takeoff weight: 65,090 kg | 143,500 lb | Maximum landing weight: 55,338 kg | 122,000 lb

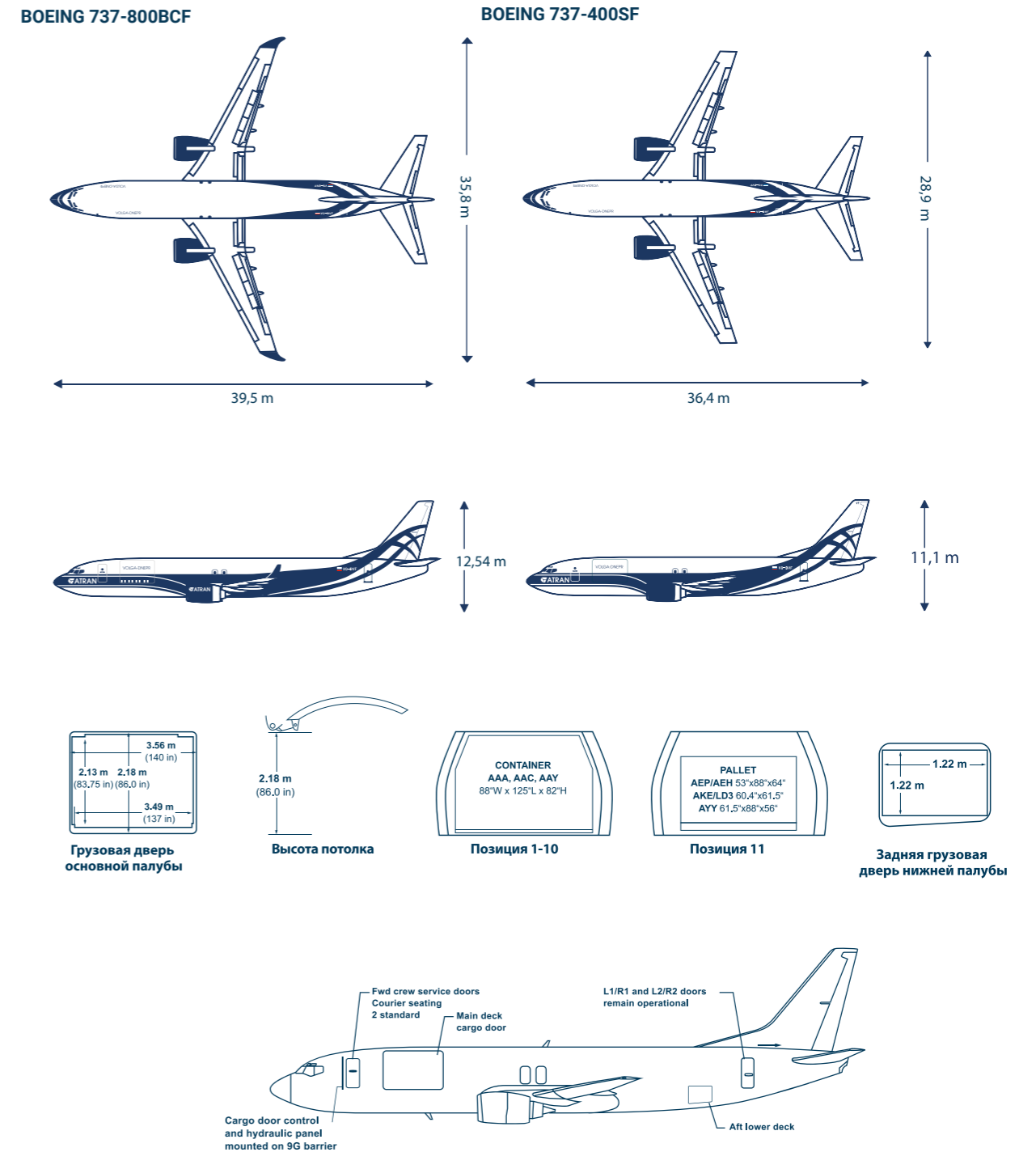

Cargo volume	Boeing 747-400F (ERF)	Boeing 747-8F	Boeing 737-800BCF	Boeing 737-400SF
Main Deck Volume	607.7 m ³ / 21,462 ft ³	692.7 m ³ / 24,462 ft ³	141.5 m ³ / 4,979 ft ³	130 m ³ / 4,590 ft ³
Pallets, total number	30	34	11+1	10+1
Lower Hold Volume	130,3 m ³ / 4601 ft ³	150 m ³ / 5,330 ft ³	-	-
Bulk	14 m ³ / 494 ft ³	14 m ³ / 520 ft ³	-	-

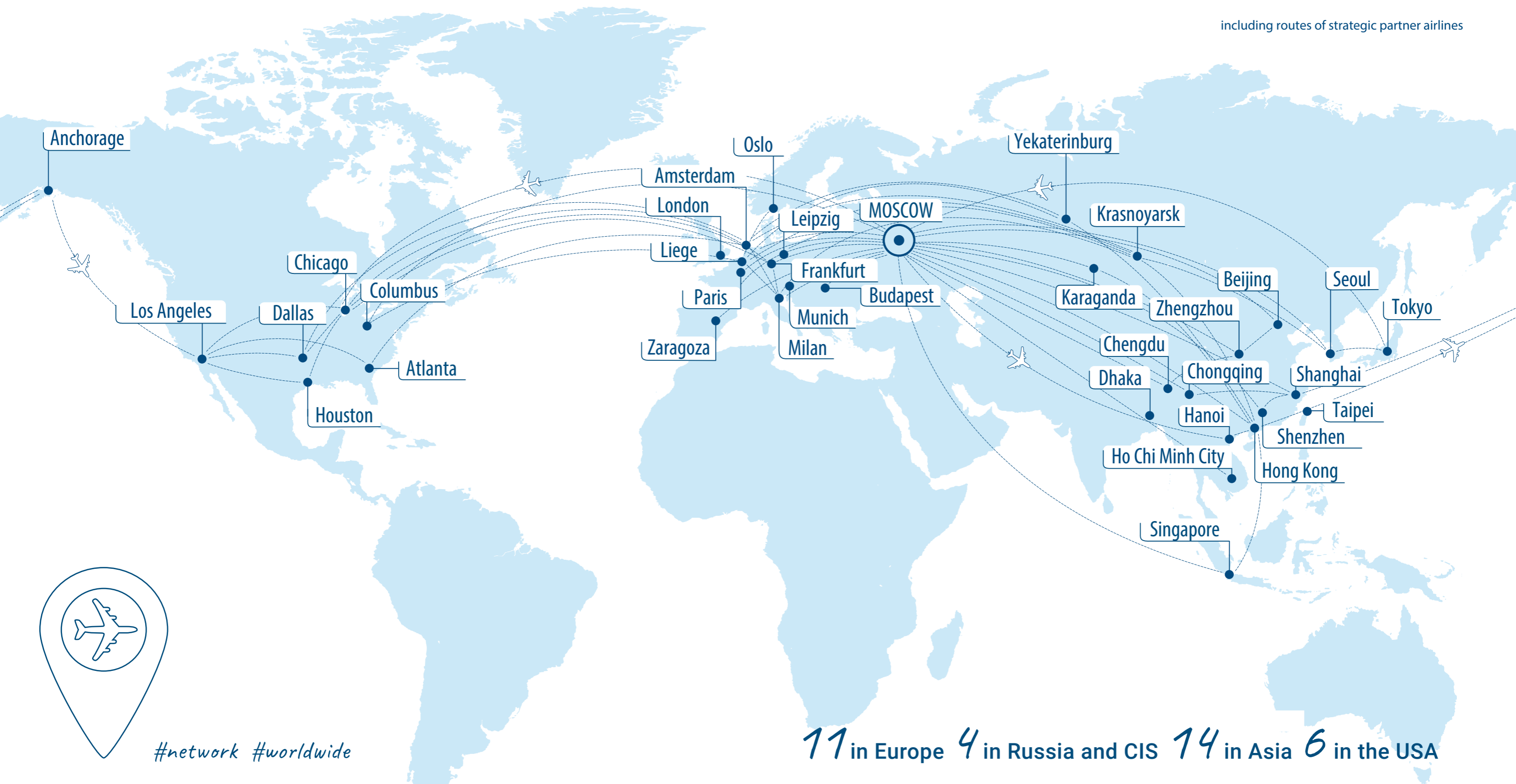

You like knowing the possibilities are endless.

AirBridgeCargo's extensive network provides customers with the opportunity to connect their production and consumption centers in the most efficient way. Its hub network model, with flight connectivity in Moscow, offers a wide choice of origin and destination cities and enables customers to access connections within a 48-hour delivery time, including cargo handling.

Connecting customers to the world's largest cargo markets

The airline's network covers Europe, Asia, Northern America, Russia and CIS. Currently, AirBridgeCargo performs over 350 weekly flights from its online stations worldwide, both via the airline's hub in Moscow and directly.

ABC's global network is complemented by the scheduled flights of ABC's interline and strategic partners, as well as extensive trucking services.



Safety, Security, Quality

...these are the three pillars, the foundation of our business. As one of the leading cargo airlines worldwide, it is our mission to be at the forefront of the latest technological advances and industry developments. Here's what we do to achieve and maintain our promise:

Safety

Safety always comes first for us. We want to make sure nobody is harmed during the transportation of your cargo – whether up in the air or on the ground. From our own safety program and corporate policy to international standards and aviation accident prevention systems, we work hard to ensure safety at each step of transportation.

- ABC's internal flight safety management and aviation accident prevention code is based on ICAO's accident prevention manual and strict internal standards.
- Active member of International Air Transport Association (IATA) and its programs designed to improve safety, quality, and efficiency in the air cargo supply chain.
- IOSA Registered Operator, an operational safety audit for global safety management in airlines
- CargoIQ member, a program that has the goal of implementing a new quality management system for the worldwide air cargo industry.

Security

International aviation security standards and an innovative monitoring system are at the heart of ABC operations – and they guarantee our high level of security.

- ABC's cargo safety and security program was founded on the company's stringent internal company processes for every stage of the cargo delivery process, managed centrally at ABC's Moscow hub.

Quality

Quality is at the core of our business principles. This principle goes hand in hand with reliability, safety and security.

- A modern, up-to-date freighter fleet of Boeing 747-400F and B747-8F
- Member of the Cool Chain Association, an association designed to improve the quality of the temperature sensitive supply chain.
- IATA CEIV Pharma certification, confirmation that quality procedures for the transportation of pharma products, fully comply with IATA's standards.
- On-Time Performance (OTP) – developing 'best-in-class' OTP for customer is another daily focus for ABC, which operates a high 'Delivered as Promised' index

Investing in our people

ABC's global team of experienced air cargo professionals unites over 1,300 employees around the world, and brings together local market knowledge and expertise with a global business understanding of how to consistently deliver value to ABC's customers. The airline combines the ambitious young talent within Volga-Dnepr Group with the extensive experience of its top industry professionals to achieve a fresh outlook on the industry and customers' current and future needs. This way, ABC ensures proactive, dynamic and professional services.

Potential realized.



«We always strive to deliver as promised. My team and I believe in efficiency and personalized, quality customer service. Our customers appreciate that. **That's why we love our job.**»



«At ABC, we work hard to find new ways to constantly improve our cargo operations. Our team is made up of bright minds that create fresh ideas to leave a lasting, sustainable mark on our customers' businesses. **That's why we love our job.**»

You like knowing you're in qualified hands.

Supporting customers worldwide

The success of its customers is the success of AirBridgeCargo. Transparency, future-oriented thinking and business partnerships based on trust as well as a hard-working mentality make ABC unique in an industry that is dominated by technology and performance. AirBridgeCargo is made up of people working with other people, and ABC's knowledgeable cargo experts are always happy to go the extra mile to deliver value to the business interests of customers.

To ensure fast and proactive customer support and direct feedback on every shipment, ABC has sales offices in locations across the entire network. The airline takes responsibility for cargo shipments from the beginning to the very end. AirBridgeCargo also offers additional services: capacity reservation and priority booking, the possibility to charter airplanes, on-board supervision, support with customs clearance and more. Apart from that, the



Taking your business further.

company has chosen GSA agents with proven reputations to guarantee delivery solutions for off-line sales where and when needed.

Commercial organizational structures with centralized management functions in joint Volga-Dnepr Group's offices enable ABC to provide customers with a full range of logistics solutions using the Volga-Dnepr 'cargo supermarket' concept. Customers' trust in AirBridgeCargo enabled the airline to be recognized as the 'Best All-Cargo Airline' by the Asian Freight, Logistic and Supply Chain Awards in 2017 and 2018, 'Best Overall Performance 2016' by Anama Quality Awards, and 'Best Performing Newcomer Full-freighter Cargo Airline' by BUD annual awards in 2019 and PLATINUM Air Carrier (up to 999,999 tonnes air carrier category) and Specialty Cargo Air Carrier in Air Cargo Excellence Award (2019).

Products & Services *for customers*

The excellent operating advantages of ABC's freighter fleet, the performance of the airline's highly-skilled personnel, and constant improvements of its internal processes enable the airline to carry all types of air cargo in full compliance with global industry standards.



Oil & Gas industry

- Carriage of extra-long pipes, heavy diesel generators, compressors, pumps and other large and heavy drilling equipment
- Dedicated charter/part-charter services or re-routing in case of rig down situation
- Fast oil rig emergency response support

Aerospace industry

- Commercial aviation aircraft engines & components, empty stands delivery within network in compliance with OEM handling guidelines
- Vast experience in the transportation of satellite systems and other space equipment
- Transportation of small rotorcraft, fuselages, stabilizers, ailerons, etc.
- Express delivery of AOG spare parts



abc | XL ^{over size}

ABC PRODUCT FOR OVERSIZE AND HEAVY CARGO

At AirBridgeCargo, we have more than 29 years of VolgaDnepr Group experience in transporting heavy and oversize cargo. No matter how complex the shipment, ABC offers customized logistics solutions tailored to the needs of each customer.

over size

- Loadability checks, technical assessments of cargoes for transportation, including weight distribution, packaging and more
- Highly customizable logistics solutions (from design and manufacture of frames to packaging and delivery)
- Factory visits
- Nose cargo loading capabilities for extra-long pieces
- Certified, highly skilled staff across the entire network
- Door-to-door solutions for XL cargo (with trusted trucking partners)
- Load planning with the usage of 3D simulation software
- Design and production of special basements and frames for high-density cargo
- Special Operating Procedures for the transportation of aircraft engines
- Full compliance with Boeing & OEM guidelines and internal safety policies
- Customer service support, online track&trace option for all shipments





ABC PRODUCT FOR HEALTHCARE SHIPMENTS

- Dedicated, skilled staff trained in handling healthcare products
- Boeing 747-8 and 747-400 with three compartments enabling different temperature settings from 4°C to 29°C
- Full compliance with IATA TCR and CEIV certification
- Most ABC stations are CEIV or Envirotainer QEP certified
- Exact temperature monitoring from acceptance to delivery
- Special packaging solutions and thermal blankets for palletized shipments
- Adoption of the latest digital technologies (Sky Fresh for data collecting, temperature data loggers to monitor consignment conditions, etc)
- Customer service support, online track&trace option for all shipments
- High-tech pharma hub at Moscow Sheremetyevo International Airport with effective connections to deliver cargo worldwide
- Tailor-made logistics solutions based on your individual requirements
- Sophisticated, cohesive and forward-thinking approach based on peer learning and networking through industry-related initiatives - Pharma.Aero, Pharma Gateway Amsterdam (PGA) and others

Specialized services for healthcare shipments

ABC PHARMA ACTIVE is a solution for time and temperature sensitive pharmaceutical products that need to be shipped in active containers. A variety of containers is used to keep healthcare goods as protected as possible, including dry ice technologies. Goods shipped are kept at a constant temperature throughout the entire cargo journey. Use of active containers mitigates risks for ambient temperature influence on healthcare products.



ABC PHARMA PASSIVE is the solution for prepackaged pharmaceutical products. Within required temperature ranges and by seasonal consideration of routes, healthcare goods are shipped efficiently and effectively.

SPECIFICATIONS	abc PHARMA ACTIVE	abc PHARMA PASSIVE
Active Control Containers*	+	-
B747-400 / B747-8 with 3 independently controlled temperature zones	+	+
High priority for booking and cargo loading	+	+
Thermal blankets	-	On request
SOP with Customers**	On request	On request
Special supervision	+	On request
Temperature monitoring during freight transportation chain	+	On request
Dedicated and qualified airline personnel	+	+
Route network	Active containers approved	On request

* - Envirotainer containers + cSafe containers + Dokasch containers + SONOCO containers
 ** -Standard Operational Procedures

Additional services are available on request, please contact pharma@airbridgecargo.com



Acceptance of all types of lithium metal and lithium-ion batteries, both single and in/with an equipment, throughout entire ABC network, including cases under special provisions A88, A99.

- Full compliance with IATA Dangerous Goods Regulations and ICAO Technical Instructions Doc 9284 AN/905
- Highly customized logistics solutions with personal attention
- 24/7 surveillance of shipments
- Certified and skilled specialists with the right knowledge of dangerous goods and lithium batteries transportation
- No additional restrictions on transportation of lithium batteries
- Transportation of electric-powered vehicles (BEV, HEV and EV)
- Special assistance in obtaining approvals for carriage of certain types of batteries
- Assistance with testing for safe transportation and obtaining of respective report (UN Manual of Tests and Criteria, Part III, subsection 38.3)
- Special training course 'Transportation of lithium batteries' by certified trainers
- Advisory support with respect to ready-for-carriage procedures



- Full compliance with IATA AVI regulations and other relevant international standards
- Controlled temperature zones to ensure the comfort, safety and well-being of the animals on-board
- Special handling facilities at every gateway for a smooth and qualified handling with authorized access for approved staff only
- Attention to every detail - from horse stalls, kennels, ventilation and stocking densities to documentation and communication. ABC will provide full information concerning export and import requirements (including permits), veterinary health inspections, quarantine regulations, trans-shipment requirements or any other restrictions
- Highest priority for booking and cargo loading as well as quick transit times
- All handling and transport processes are adapted to the special requirements of the animals carried
- Cargo attendants accompanying live animals on-board to control animal health and well-being
- AVI licensed Live Animal Advisory specialists
- Assistance with all documentation and IATA Live Animal Regulations' requirements
- Cooperation with local authorities to ensure fast and efficient processes at origin and destination
- Possibility to rent special transport containers including horse stalls and kennels
- More than 15 years of experience, including the safe transportation of racehorses, dolphins, whales, elite breeding stock, cattle, tigers and bear cubs



Extra care that isn't extra.



- ABC's team of perishable cargo experts is ready to undertake any challenge
- Compliance with all applicable guidelines including IATA PCR
- Possibility to provide required examinations by local phytosanitary and veterinary authorities under temperature controlled conditions
- To ensure constant temperature control, ABC offers:
 - » Temperature controlled environments during the entire flight and on the ground in the ground handling facilities at the majority of stations
 - » Temperature controlled cells at the SVO hub
 - » Availability of thermal blankets
 - » Possibility to organize RFS with reefer trucks at the majority of ABC stations
- State-of-the-art aircraft features, including environmental control systems to reduce humidity, control pressure and set independent temperature zones



For booking and more detailed information, please contact your local ABC representative.



abc | e-com

ABC PRODUCT FOR E-COMMERCE DELIVERIES

E-commerce is an emerging sector driven by ever-increasing demand for cross-border purchases and is led by customer expectations of receiving high-quality 'one-click' services through online market places and platforms. We like improving your customer experience and aim to continuously develop our logistics solutions for fast, seamless, and effective delivery of shipments for this sector. Our global network coverage gives unlimited access to major e-commerce trade lanes.

Always. Worldwide.

- Access to major e-commerce flows through ABC global network
- Up to 8 flights per day from the biggest e-commerce contributing hubs – Hong Kong, Shanghai, Beijing, and Shenzhen
- Special solutions for packaging of low-density cargo, with the usage of stabilizer racks or AMU containers to reach maximum volume and protection during transportation process
- Customized solutions according to our customers' requirements
- Highly skilled specialists throughout ABC network with regional expertise and global market outlook

Special packaging solutions

AirBridgeCargo pays great attention to safety of cargo and fast handling services. In doing so, our Logistic Engineering center together with leading manufacturing companies design special equipment (stabilizing racks), which can be used as an additional tool for transportation of light but volumetric e-commerce cargo.

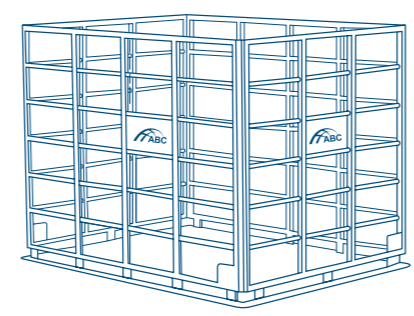
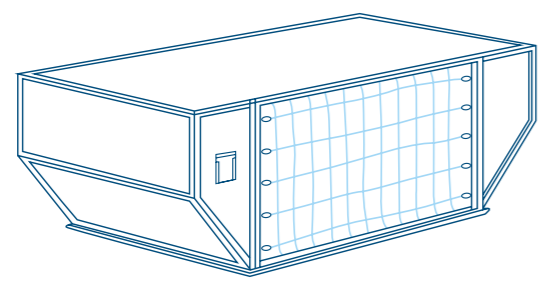

abc | premium

ABC PRODUCT FOR GUARANTEED FLIGHT CAPACITY

Abc premium is our advanced solution with guaranteed capacity at a specific flight and date. Whenever your shipment might be - the latest model of high-tech gadget, semiconductors, or fashion clothing, our abc premium product is the perfect match with high priority status to be flown as planned. At ABC we work to make it happen for you. **Always. Worldwide.**



- Guaranteed capacity throughout the whole network
- Highest priority booking
- Certified and experienced staff across the entire ABC network
- Modern fleet of efficient freighters with a main deck capacity
- Transportation of special cargoes
- Access to flights of ABC's interline and other airline partners

abc | general

ABC PRODUCT FOR YOUR GENERAL CARGO

Reliable and efficient delivery of your cargo with AirBridgeCargo. Our scheduled service has been developed with standard cargo shipments in mind. With over cargo 30 destinations and access to scheduled flights of our airline partners, we can get your freight almost anywhere. With us, you are connected to all major business hubs. **Always. Worldwide.**



- Modern fleet of efficient freighters with a main deck capacity
- Up to 130 tonnes of cargo capacity per flight
- Global network with access to more than 30 major cargo gateways
- Access to flights of ABC's interline and other airline partners
- Customer service support, online track&trace option for all shipments
- Assistance with all required permits and import/export documentation
- Certified and experienced staff across the entire ABC network

abc | charter

ABC PRODUCT FOR YOUR SPECIAL PROJECTS

Meeting and exceeding the expectations of our customers is our number one goal, which is why ABC offers the possibility to charter Boeing 747 flights. We operate charters to any point of destination. There are hardly any limits when it comes to point of origin and point of destination, as well as our ability to organize charter flight.



- Modern fleet of efficient freighters with a main deck capacity
- Up to 130 tonnes of cargo capacity per flight
- More than 15 years of experience in dealing with charter requests handling with proven scheme of communication with all the parties involved
- Specialty cargo transportation with dedicated procedures and personnel in place
- Access to fleet capacity of other airlines within
- Volga-Dnepr Group (An-124-100, Il-76TD-90VD, B737F)
- Certified and experienced staff across the entire ABC network
- Assistance with all the documents required for charter operations
- Possibility of cargo attendance in case needed (for live animals, valuable cargo, etc)
- Customer service support



abc | valuable

ABC SERVICE FOR VALUABLE CARGO

All your shipments are special to us, but some require extra special handling. From artwork to jewellery and beyond, we handle your valuable cargo with absolute discretion and confidentiality and guarantee it will get to its destination safely. We work hard to offer our customers exceptionally high security standards and 24/7 security surveillance of all valuable shipments. At AirBridgeCargo, you get that extra peace of mind. **Always. Worldwide.**

- Possibility of cargo attendants to accompany and monitor theft endangered goods on board
- Full freighter fleet with state-of-the-art temperature control system (+4 to +29°C)
- Full transparency at each stage of transportation coordinated by our dedicated Control Tower (24/7) and supported by an online Track & Trace system at www.airbridgecargo.com

Additional security measures in Sheremetyevo cargo hub in Moscow:

- High-tech goods and ULD are inspected for any damage visually or with the use of special tools
- In case of detection of any damage, ABC representative is informed immediately
- Video surveillance during the entire process of loading and unloading process
- In case of tail-to-tail operations at least two aviation security officers are present at the time of offloading, transporting and reloading on board another aircraft

We move valuable cargo with *knowledge and discretion*

Throughout the entire journey, our cargo experts work closely together to ensure the professional and reliable handling of all valuable goods to prevent any possible damage, including mechanical shocks and adverse weather conditions.

abc | extraSAFE

ABC SERVICE FOR VULNERABLE CARGO

Electronic gadgets, fashion clothes, high-value telecommunications and computer equipment are everyday essentials of our life. These items are sensitive to theft and require a high level of expertise. With more than 15 years of experience, AirBridgeCargo is an expert in providing safe and reliable transportation of vulnerable cargo across its entire international network. **Always. Worldwide.**

- Highly customizable logistics solutions
- Photo control at each stage of transportation, additional video control upon request
- The possibility to transport through our cargo hub in Moscow
- Smooth operations guaranteed by Control Tower (24/7)
- Full transparency at each stage of transportation coordinated by our dedicated Customer Service Team
- Possibility for cargo attendants to accompany precious shipments

Your benefits

- Priority shipment status of your vulnerable cargo
- Developed procedures increasing the safety of the cargo
- Multi-level security control
- Monitoring from acceptance to delivery
- Dedicated storage area with 24/7 security surveillance
- Certified and trained personnel across the entire ABC network

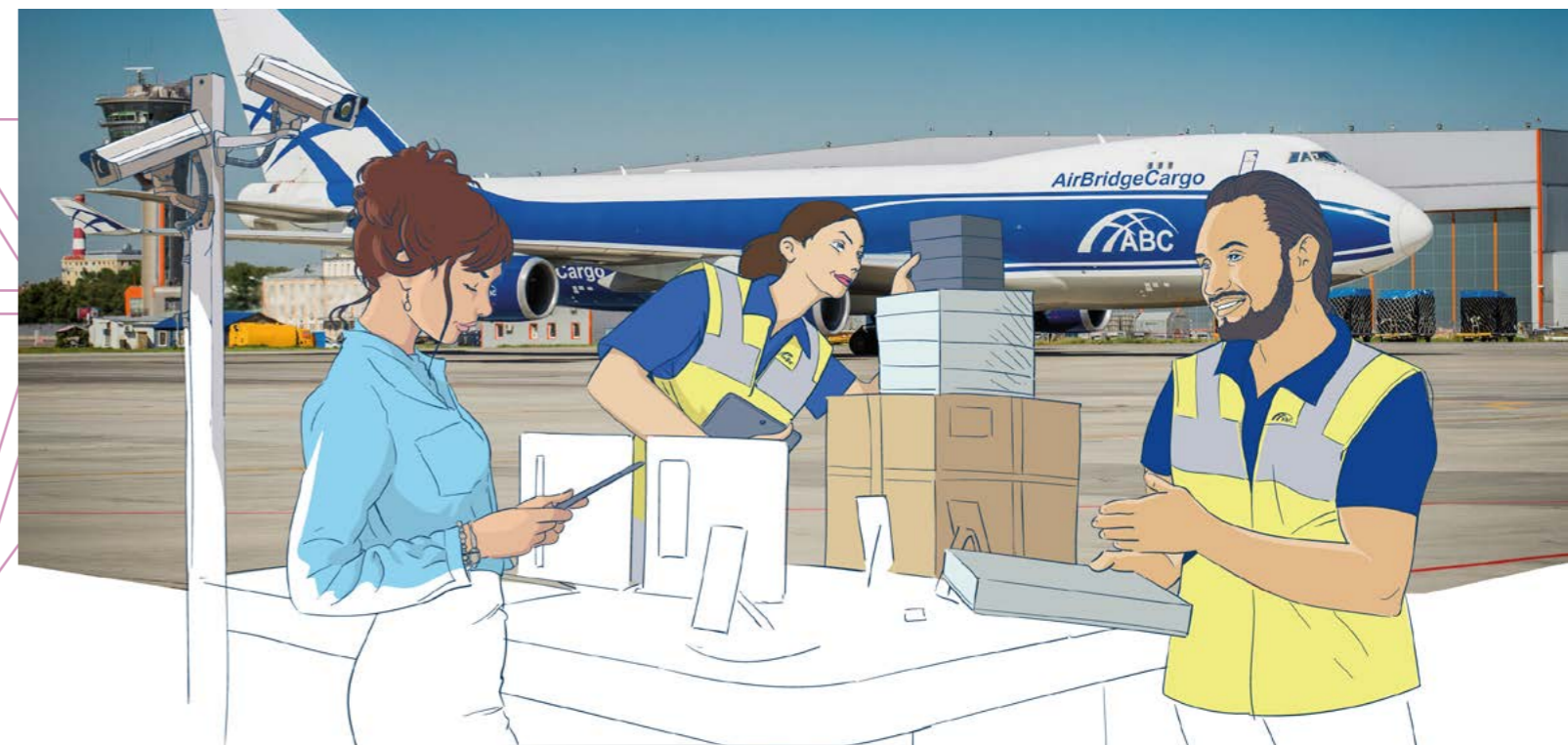
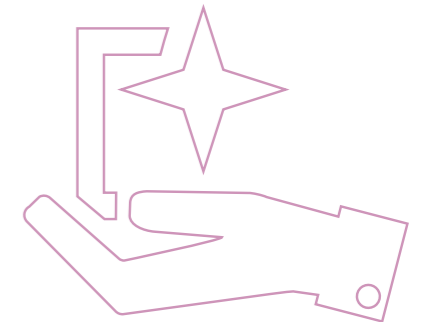

Our abc extraSAFE offers dedicated services tailored to your needs, guaranteeing constant customer service support and assistance at each stage of transportation.



ABC SERVICE FOR DANGEROUS GOODS

Safe, consistent and reliable. From simple consumer goods (aerosols, paints and perfumery products) up to highly radioactive materials used in manufacturing and medicine - we understand that certain cargo has special shipping requirements. At ABC, we are fully equipped to handle and deliver dangerous cargo, and are able to offer customized logistics solutions tailored to the needs of each shipment based on our experience and knowledge of regulations for transportation of dangerous goods. **Always. Worldwide.**

- Full compliance with IATA Dangerous Goods Regulations and ICAO Technical Instructions for the Safe Transport of Dangerous Goods by Air, Doc 9284 AN/905
- Fully certified to transport all Classes of dangerous goods
- License for transportation of radioactive materials and fissile materials - Uranium/Plutonium (class 7)
- Acceptance of all types of lithium metal and lithium-ion batteries, both single and in/with an equipment, including cases under special provisions A88, A99
- Transportation of electric-powered vehicles (BEV, HEV and EV)
- Special assistance in obtaining approvals for carriage of certain goods
- Certified and trained personnel across the entire ABC network
- Highly customizable logistics solutions
- 24/7 surveillance of shipments

Special attention for special cargo

CONTROL TOWER

AirBridgeCargo Airlines has established a new 24/7/365 Control Tower (CT) operation to monitor consignments of special cargoes and to proactively respond to service disruptions to ensure it consistently meets customers' delivery deadlines. Managed by a team of fully trained supply chain specialists and based in Moscow, HQ the Control Tower provides:

- Real-time, round-the-clock monitoring of all cargo movements throughout the entire transportation process across ABC's network
- Checkup of ABC's fleet technical condition (temperature control system, cargo handling system readiness)
- Schedule alignment and control for priority delivery of special cargo
- Communication with ABC specialists from different departments and customers in case of deviations for prompt response
- Cargo status updates and reports
- CT personnel availability 24/7 via e-mail, skype or direct phone line

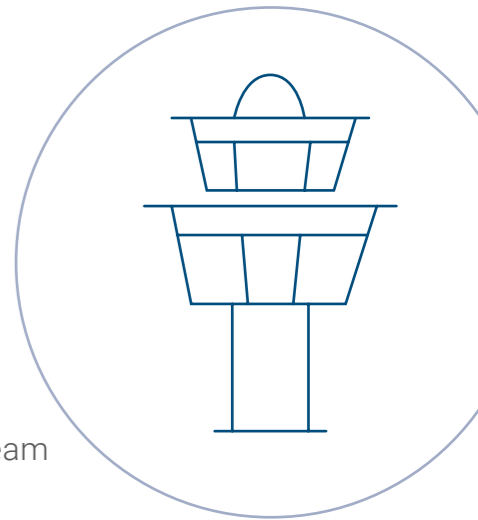

Our SVO Moscow Hub

ABC's Moscow hub at Sheremetyevo airport features modern equipment in each warehouse, allowing for efficient, seamless and safe handling of any type of cargo - from live animals to dangerous substances and beyond. Our decision to develop SVO Moscow hub was an important milestone in the history of the company and a strategic step on our path to become a network carrier. Our hub network model and flight connectivity in Moscow lets our customers access connections within a 48-hour delivery time - including handling. The cargo terminal facilities have direct access to the airside apron, facilitating a seamless flow of cargo.

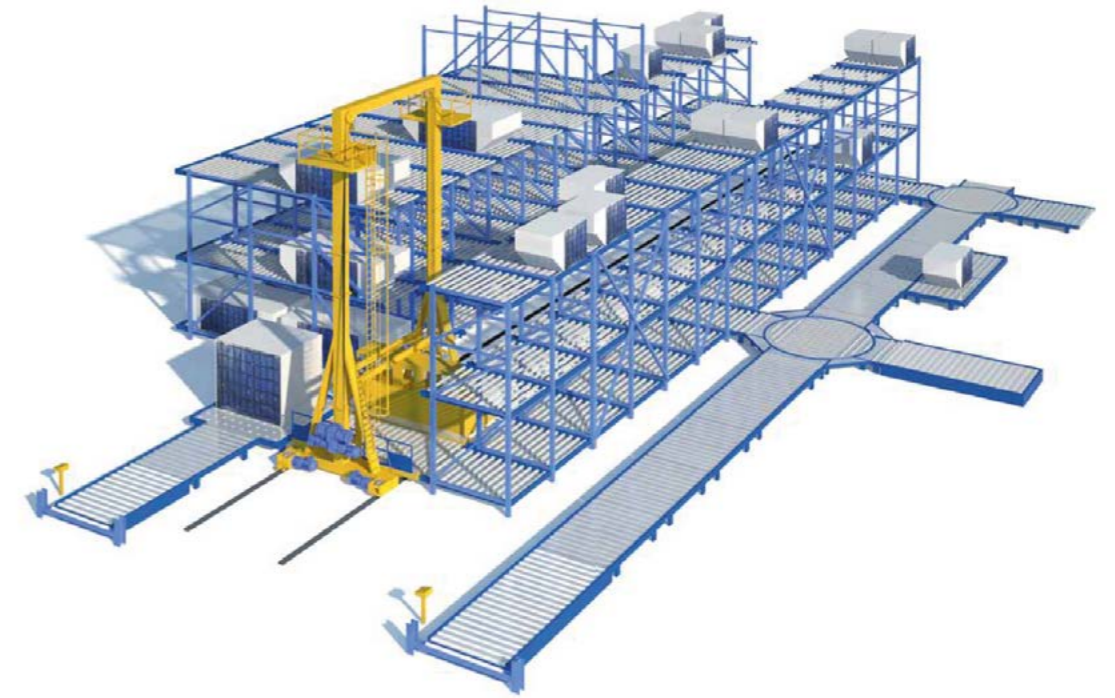

Hub facilities

- 3 warehouses in SVO
- 20 000 sq m – total area of warehouses in SVO
- first automated cargo handling system in Russia with three-dimensional cargo handling on several levels
- 24/7 video surveillance
- 137 cameras
- 99,98 Safety index
- TAPA certified
- Refrigerators for perishable cargo
- 380 cub m area for temperature controlled cargo
- Temperature control from -30C to +10C
- Dedicated pharmacy warehouse
- Dedicated area for dangerous goods

Cargo enhanced security

- High-tech goods and ULD are inspected for any damage by visual inspection or with the use of special tools
- In case of detection of any damage, an ABC representative is informed immediately
- The entire process of loading and unloading is under video surveillance
- In case of tail-to-tail operations at least two aviation security officers are present at the time of unloading, transporting and loading on another board
- Two security officers are permanently on duty to protect cargo, cargo storage and bandwidth access mode at the warehouse
- Dedicated area for dangerous goods

With more than 15 years of experience, ABC team is always ready to assist its customers with timely and effective logistics solutions, based on customers' expectations and needs.

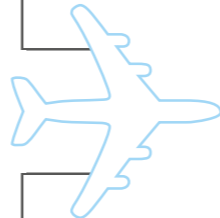



Russia

Moscow Head Office

Building 3, 28B, Mezhdunarodnoe road
Business center "Skypoint"
Moscow, Russia 141411
T: +7 495 7862613
Fax: +7 495 7556581
info@airbridgecargo.com

SPAIN Zaragoza

Airnautic Spain– General Sales Agent of
AirBridgeCargo Airlines
Edificio de Servicios Generales, Of.A-314
08820 El Prat de Llobregat, Spain
T: +34 93 829 24 70
c.martinez@airnautic.aero
eric.lamare@airbridgecargo.com

Atlanta

PO Box 20716
Atlanta, GA 30321
Sales/customer service:
P: 1 404-766-3545
abcsales.atl@airbridgecargo.com
service.usa@airbridgecargo.com

JAPAN Tokyo

Onarimon Yusen Bldg 9F 3-23-5 Nishi-Shinbashi
Minato-ku, Tokyo 105-0003
Tel.: +81 3 5777 4025
for service enquiries:
service.nrt@airbridgecargo.com
for sales enquiries:
sales.jpn@airbridgecargo.com

Europe

GERMANY Frankfurt am Main

CargoCity South, Bldg. 534/6th floor
D-60549 Frankfurt am Main
T: +49 69 638 097 –100
Fax: +49 69 638 097 –101
service.fra@airbridgecargo.com

FRANCE Paris

AirBridgeCargo Airlines
Zone de Fret 6
20, rue du Pavé / Bat B4
95704 Roissy CDG, France
P: +331 74 25 06 03
service.cdg@airbridgecargo.com

NETHERLANDS Amsterdam

Anchorageaan 50
1118 LD Schiphol Airport
T: +31 20 654 9030
Fax: +31 20 654 9044
sales.ams@airbridgecargo.com

ITALY Milan

Via Monzese, 34
20060 Vignate (MI), Italy
T: + 39 02 959395140
service.mxp@airbridgecargo.com

USA

Chicago

836 Patton Drive, Bldg. E, Suite 237
Bldg. D (From Export & drop station)
Chicago, IL 60666
T: +1 773 800-2361
Sales/customer service:
abcsales.ord@airbridgecargo.com
service.usa@airbridgecargo.com

Dallas

Suite 295 - Bldg. 300, 1639 W. 23rd Street
DFW Intl Airport, TX 75261
T - Export: +1 469 629 0479
T - Import: +1 214 296 03 74
Sales/customer service:
abcsales.dfw@airbridgecargo.com
service.usa@airbridgecargo.com

Los Angeles

5761 W Imperial Hwy, Los Angeles, CA 90045
T: +1 310 258 6100 ext. 3902, 3903, 3904, 3905
For import enquiries:
abccops@mercuryair.com
Sales/customer service:
abcsales.lax@airbridgecargo.com
service.usa@airbridgecargo.com

China

Hong Kong

Room 430, 4/F.South Office Block
Super Terminal One
Hong Kong International Airport
Chep Lap Kok, Hong Kong
T: +852 2215 3928
Fax: +852 2215 3878
service.hkg@airbridgecargo.com

Beijing

Room 2006B, Air China Plaza
No 36 xiaoyun Road
Chaoyang District
Beijing 100027.PRC
T: +86 10 8447 5936/37/38
Fax: +86 10 8447 5935
service.pek@airbridgecargo.com

Shanghai

Room 3105, Shanghai Maxdo Center
8 Xingyi Road, Shanghai
P.R. China 200336
T: +86 21 52080011
Fax: +86 21 52080508
service.pvg@airbridgecargo.com

SOUTH KOREA Seoul

Room 604, 6th Floor, Seoul Center Building
116, Sogong-ro, Jung-gu,
Seoul, 04533, Korea
T: +82 2 712 5803
T: +82 70 4136 5804
E-mail: yb.ha@airbridgecargo.com

SINGAPORE Singapore

Room 238, Level 2, Core F, SATS AirFreight
Terminal 3
105 Airport Cargo Road
Singapore 819462
T.: +65 6214 9424
service.sin@airbridgecargo.com

VIETNAM Hanoi

Room 343, ALS Cargo Terminal
Noi Bai International Airport
Soc Son District
Hanoi, Vietnam
T: +84 38501339
T: +84 902421339
han.ops@airbridgecargo.com



www.airbridgecargo.com



© May 2019



Part of Volga-Dnepr Group